

ARCTIS



Electronic Freezer no_frost

Operating Instructions

Dear customer,

Before placing your new freezer into operation please read these operating instructions carefully. They contain important information for safe use, for installation and for care of the appliance.

Please keep these operating instructions for future reference. Pass them on to possible new owners of the appliance.



Notes which are important for your safety or for the proper functioning of the appliance are stressed with a warning triangle and/or with signal words (**Warning!**, **Caution!**, **Important!**). Please observe the following carefully.



1. This symbol and numbered instructions guide you step by step in the operation of the appliance.

2.



Supplementary information regarding operation and practical applications of the appliance appear after this symbol.



Tips and notes concerning economical and environmentally sound use of the appliance are marked with the cloverleaf.

Explanations of the technical terminology used in the operating instructions can be found at the end in the section "Technical Terminology".

The operating instructions contain instructions for the correction of possible malfunctions by the user in the section "What to do if ...". If these instructions should not be sufficient, please contact your local AEG Service Force Centre.

Printed on paper manufactured with environmentally sound processes.
he who thinks ecologically acts accordingly ...

Contents

Important Safety Instructions	5
Environmental Information	7
Appliance Transport	7
Before Use	8
Packaging	8
Fitting the Door Handle	8
Installation	9
Installation Location	9
The freezer needs ventilation	9
Appliance Alignment	10
Electrical Connection	10
Reversing the door	11
The no-frost (frost free) system	14
Description of the appliance	15
View of the appliance	15
Cold accumulation block	15
Control Panel	16
Temperature setting buttons	16
Temperature display	17
TURBO/FROSTMATIC-button	18
ALARM OFF button	18
Prior to Initial Start-Up	19
Initial use	19
Select "Freezing" or "Cooling"	20
Temperature Adjustment	20
Switching the Appliance Off	21

Control and Information Systems 22

"Open Door" Warning 22

Temperature Warning 22

Temperature memory 23

Function Errors 23

Opening the door 23

Freezing 24

Frozen Storage 25

Preparation of Ice Cubes 25

Storage Goods Symbols/Freezing Calendar 26

Maximum Load 26

Cooling 26

"Long Fresh" Cooling 26

"Standard" Cooling 27

Cooling drinks 27

Hints and Tips 28

Normal Operating Sounds 28

Food Storage 28

Energy Saving Advice 28

Maintenance and Cleaning 29

 Internal Cleaning 29

 External Cleaning 29

What to do if 30

Correcting Malfunctions 30

Replacing the light bulb 32

Regulations, Standards, Guidelines 32

Technical Terminology 33

Guarantee Conditions 34

Service & Spare Parts 35



Important Safety Instructions

These warnings are provided in the interests of your safety. Ensure that you understand them all before installing or using this appliance. Your safety is of paramount importance. If you are unsure about any of the meanings of these warnings contact the Customer Care Department.

Prior to Installation

- Check the freezer for transport damage. Under no circumstances should a damaged appliance be installed! In the event of damage, please contact your retailer.

Installation

- This appliance is heavy. Care should be taken when moving it.
- It is dangerous to alter the specifications or attempt to modify this product in any way.
- Ensure that the appliance does not stand on the electrical supply cable. If the supply cable is damaged, it must be replaced by a cable available from your local Service Force Centre.
- Make sure that the power plug is not squashed or damaged by the back of the appliance. A damaged power plug may overheat and cause a fire.
- If the power plug socket is loose, do not insert the power plug. There is a risk of electric shock or fire.
- Any electrical work required to install this appliance should be carried out by a qualified electrician or competent person.
- Parts which heat up should not be exposed. Whenever possible, the back of the appliance should be close to a wall, but leaving the required distance for ventilation, as stated in the installation instructions.
- The appliance should be left for 2 hours after installation before it is turned on, in order to allow the refrigerant to settle.

Refrigerant

The refrigerant isobutane (R600a) is contained within the refrigerant circuit of the appliance, a natural gas with a high level of environmental compatibility, which is nevertheless flammable.

- During transportation and installation of the appliance, be certain that none of the components of the refrigerant circuit become damaged.

- If the refrigerant circuit should become damaged:
 - avoid open flames and sources of ignition;
 - thoroughly ventilate the room in which the appliance is situated.

Child Safety

- Do not allow children to tamper with the controls or play with the product.
- Keep packaging material away from children! (There is a risk of suffocation!)

During Use

- This appliance is designed for domestic use only, specifically for the storage of edible foodstuffs only. It is not intended for commercial or industrial use.
- Containers with flammable gases or liquids can leak at low temperatures. Do not store any containers with flammable materials such as, spray cans, fire extinguisher refill cartridges etc in the freezer.
- Frozen food should not be refrozen once it has thawed out.
- Do not place carbonated or fizzy drinks in the freezer.
- Ice lollies can cause 'frost/freezer burns' if consumed straight from the freezer compartment.
- Do not remove items from the freezer compartment if your hands are damp/wet, as this could cause skin abrasions or frost/freezer burns.
- Bottles and cans must not be placed in the freezer. They can burst when the contents freeze.
- Manufacturers' recommended storage times should be adhered to. Refer to relevant instructions.

Maintenance and Cleaning

- Before cleaning, always switch off the appliance and disconnect from the electrical supply.
- When unplugging always pull the plug from the mains socket, do not pull on the cable.

Servicing

- This product should be serviced by an authorised engineer and only genuine spare parts should be used.
- Under no circumstances should you attempt to repair the appliance yourself. Repairs carried out by inexperienced persons may cause injury or serious malfunctioning.
Contact your local AEG Service Force Centre.

Environmental Information



Packaging material

The packaging materials are environmentally friendly and can be recycled. The plastic components are identified by markings, e.g. >PE<, >PS<, etc. Please dispose of the packaging materials in the appropriate container at your local waste disposal facilities.



Old appliance

The symbol  on the product or on its packaging indicates that this product may not be treated as household waste. Instead it shall be handed over to the applicable collection point for the recycling of electrical and electronic equipment. By ensuring this product is disposed of correctly, you will help prevent potential negative consequences for the environment and human health, which could otherwise be caused by inappropriate waste handling of this product. For more detailed information about recycling of this product, please contact your local city office, your household waste disposal service or the shop where you purchased the product.

Appliance Transport

Two persons are required to transport the appliance. There are two recessed handles at the front of the base and at the back of the appliance at the top for improved gripping.

-  1. Grip the appliance with the recessed handles positioned as in the drawing, and transport the appliance.

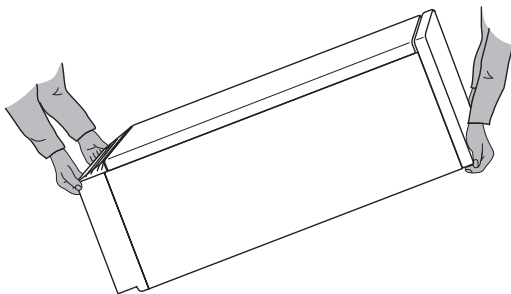

2. In order to push the appliance into its final position, press carefully at the top of the door and tip the appliance back slightly. The weight is then transferred to the back wheels and the appliance can be easily pushed.

Before Use

Packaging

 1. Remove all adhesive tape and packaging from the interior of the appliance.

 Any remnants of adhesive can be removed with white spirit.

2. Remove the transport protection pieces and pull off the adhesive tape.

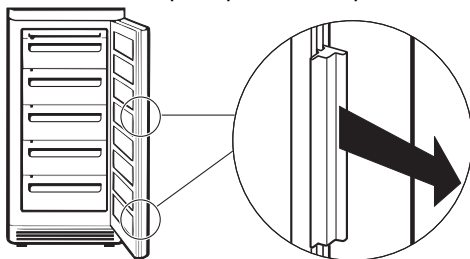

3. Wash the inside of the appliance with lukewarm water with a little bicarbonate of soda added (5 ml to 0.5 litre of water). Do not use soap or detergent as the smell may linger. Dry the appliance thoroughly.

Fitting the Door Handle

 **Caution!** Do not overtighten the screws (max. 2 Nm) as you may damage the door handles.

 1. Screw the top handle bracket to the handle rod (1). Fit the bottom handle bracket on the lower left-hand side of the door (2).

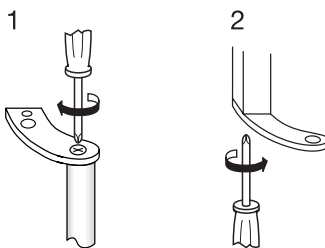

2. Fit the top handle bracket on the top left-hand side of the door (3) and screw the handle rod to the bottom handle bracket (4).

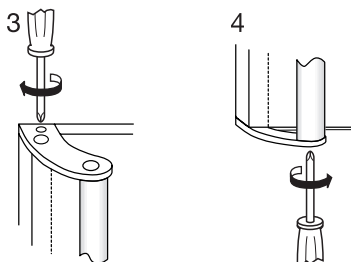

Installation

Installation Location

The appliance should be installed in a well ventilated, dry room.

Energy use and efficient performance of the appliance is affected by the ambient temperature.

The appliance should therefore

- not be exposed to direct sunlight;
- not be installed next to radiators, cookers or other sources of heat;
- only be installed at a location whose ambient temperature corresponds to the climate classification, for which the appliance is designed.

The climate classification can be found on the rating plate, which is located at the left on the inside of the appliance.

The following table shows which ambient temperature is correct for each climate classification:

Climate classification	for an ambient temperature of
SN	+10 to +32 °C
N	+16 to +32 °C
ST	+18 to +38 °C
T	+18 to +43 °C

The freezer needs ventilation

Air is fed under the door through the vent slots in the base and is exhausted upwards along the back wall. To ensure proper air circulation never cover or alter the vent openings.

Important! If the appliance is installed under, for example, a hanging cabinet, a clearance of at least 10 cm between the top of the appliance and the cabinet above it must be maintained.

Please check whether, after installing your appliance and especially after reversing the door, the door seal fits tightly. A badly fitting door seal may lead to heavy frosting and a higher power consumption (see also "Something not working").

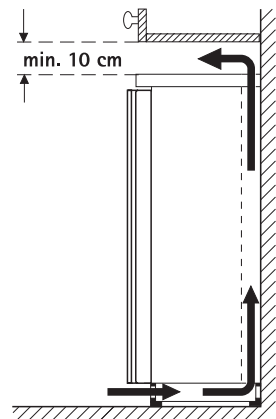

Remove the two wall spacers from the appliance accessories pack and, in accordance with the illustrations, fix them at the top of the rear of the appliance so that the distance from the wall required for the necessary ventilation is ensured.

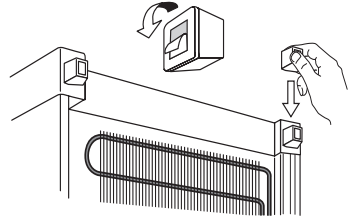

Appliance Alignment

- 1. The appliance must be level. Please compensate for unevenness in the floor by turning the two adjustable feet at the front.

Electrical Connection

Any electrical work required to install this appliance should be carried out by a qualified electrician or competent person.



WARNING – THIS APPLIANCE MUST BE EARTHED

The manufacturer declines any liability should these safety measures not be observed.

Before switching on, make sure the electricity supply voltage is the same as that indicated on the appliance rating plate. The rating plate is inside, on the left.

The appliance is supplied with a 13 amp plug fitted. In the event of having to change the fuse in the plug supplied, a 13 amp ASTA approved (BS 1362) fuse must be used.

Important

The wires in the mains lead are coloured in accordance with the following code:

Green and Yellow	Earth
Blue	Neutral
Brown	Live

As the colours of the wires in the mains lead of this appliance may not correspond with the coloured markings identifying the terminals in your plug, proceed as follows:

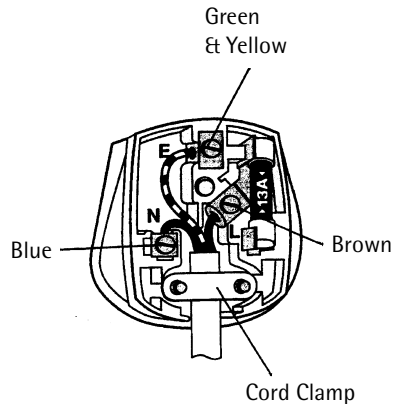



1. The wire coloured green and yellow must be connected to the terminal marked with the letter "E" or by the earth symbol \oplus or coloured green and yellow.
2. The wire coloured blue must be connected to the terminal "N" or coloured black.
3. The wire coloured brown must be connected to the terminal marked "L" or coloured red.
4. Upon completion there must be not cut, or stray strands of wire present and the cord clamp must be secure over the outer sheath.

 **Warning!** A cut-off plug inserted into a 13 amp socket is a serious safety (shock) hazard. Ensure that the cut-off plug is disposed of safely.

Reversing the door

The door hinges can be changed from right (as supplied) to left if required to suit the location where the appliance is installed.

 **Warning!** Unplug from the mains before reversing the door.

-  1. Open the door and remove the plinth cover to the front. Move the door hinge bracket cover on the plinth cover from the left to the right. Close the door.

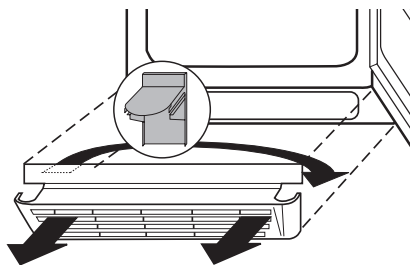

2. With the door closed, remove the cross-head screws from the lower door hinge bracket and remove the door hinge bracket downwards.

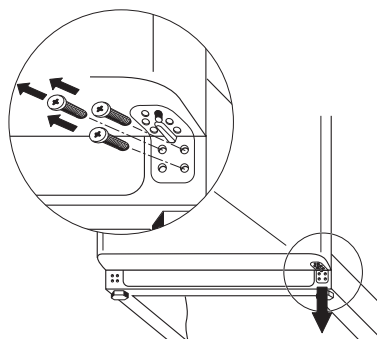

3. Remove the door fitting from the door hinge bracket (1, 2). Move the hinge bracket pivot from the right to the left hand hole (3). Place the door fitting supplied on the hinge bracket pivot (4, 5).

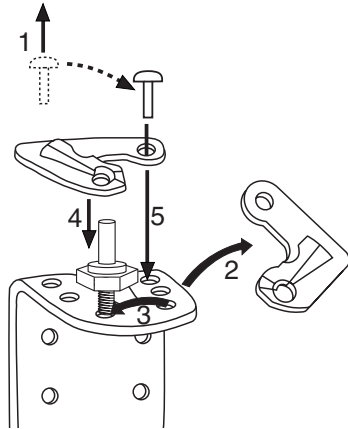

4. Unscrew Phillips screw from the door bottom right and remove door fitting (1). Insert door fitting supplied in the door bottom left and fasten with Phillips screw (2). Carefully remove the door to the front and place on one side.

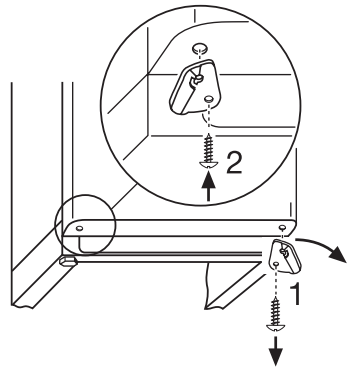

5. Move the upper hinge bracket pivot to the left.

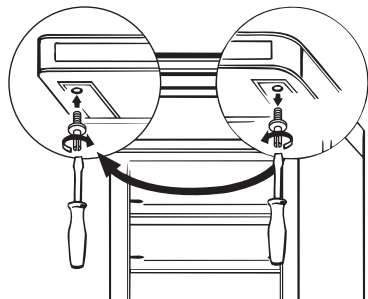

6. Carefully slide the door onto the top hinge bracket pivot and close.

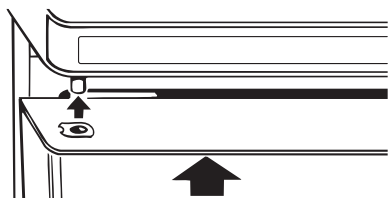

7. Place the lower door hinge bracket with the hinge bracket pivot in the lower left of the door and fasten.

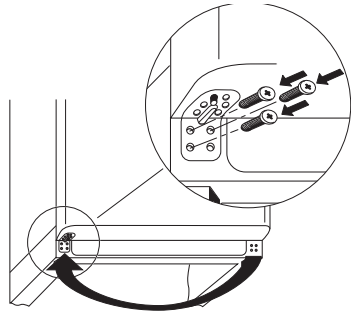

8. Unscrew the top handle bracket from the handle rod (1). Unscrew the bottom handle bracket from the door (2).

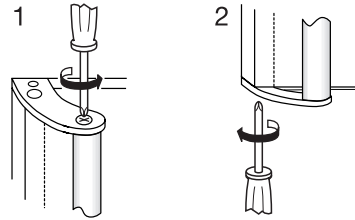

9. Unscrew the top handle bracket from the door (3) and screw onto the bottom right-hand side of the door (4).

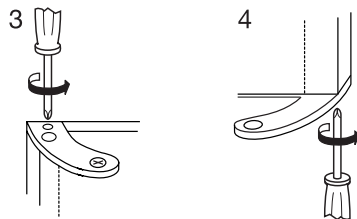

Caution! Do not overtighten the screws (max. 2 Nm) as you may damage the door handle.

10. Turn the handle bracket with the handle rod 180° and screw them to the door (5) and the fitted handle bracket (6).

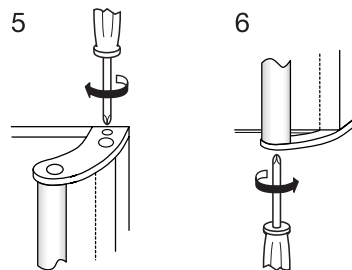

Caution! Do not overtighten the screws (max. 2 Nm) as you may damage the door handle.

11. Open the door and fit the plinth cover.

The no-frost (frost free) system

- The appliance can be used as a freezing unit or as a refrigerator depending on requirement. For this purpose, the operation mode "Freezing" or the operation mode "Cooling" can be selected on the appliance.
 - In the **operation mode "Freezing"**, the appliance is usable for freezing and deep-temperature storage with temperatures from $-15\text{ }^{\circ}\text{C}$ up to $-24\text{ }^{\circ}\text{C}$.
 - In the **operation mode "Cooling"**, this appliance can be operated as a "long fresh" cooling unit with temperatures of $0\text{ }^{\circ}\text{C}$ to $+2\text{ }^{\circ}\text{C}$, whereby a dry cabinet interior climate is attained through the no-frost (frost-free) technology. The appliance can also be used in the adjustable temperature range of up to $+16\text{ }^{\circ}\text{C}$ as a chilled cupboard for food and drink. Naturally, it is also usable as a "normal" refrigerator for the temperature range of $+2\text{ }^{\circ}\text{C}$ to $+5\text{ }^{\circ}\text{C}$.
- TURBO/FROSTMATIC can be selected depending on purpose and need.
 - In the **operation mode "Cooling"**, TURBO/FROSTMATIC is suitable for fast cooling larger quantities when in the refrigerator mode, e.g. for drinks or salads during a party. Thereby, a DESIRED temperature of $+2\text{ }^{\circ}\text{C}$ is automatically preset. After 6 hours have expired, the TURBO/FROSTMATIC function is terminated automatically.
 - In the **operation mode "Freezing"**, TURBO/FROSTMATIC caters for quick freezing of fresh foodstuffs and protects at the same time the foodstuff already stored against undesired temperature increase when in the freezer mode. The electronics of the appliance recognises automatically, when the quick freezing mode can be completed, and automatically switches off the TURBO/FROSTMATIC function. (Depending upon the quantity to be frozen after 30 up to maximum 51 hours).
- The **no-frost (frost free) system** enables both the freezing of fresh foodstuff as well as the storage of readily frozen foodstuff by cold air. An evaporator cools the air in the interior space of the appliance, which is circulated and uniformly distributed by a ventilator. This uniformly circulating air-flow creates a dry climate, low temperature fluctuations and low temperature differences in the entire appliance interior. The moisture in the air condenses as frost on the evaporator. The evaporator thaws/defrosts automatically, as soon as this is necessary. The melted water is drained off outside to the compressor and evaporates through the heat generated by the latter. Thus, the interior of the appliance and the stored cooled or frozen foodstuffs always remain fresh and ice-free. Manual thawing/defrosting is not necessary.

Description of the appliance

View of the appliance

(various models)

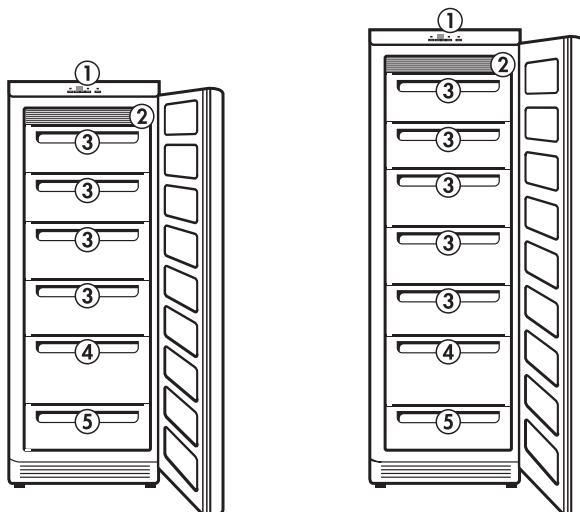

- ① Control panel
- ② Interior Illumination
- ③ Compartments with lids and drawers
- ④ Maxi-Box
- ⑤ Drawer (for frozen food storage only)

Cold accumulation block

There is one cold accumulation block in the freezer.

Refer to the section "Prior to Initial Start-Up" concerning freezing of the cold accumulation block.

- i** In the event of a power failure or malfunction, the cold accumulation block will increase the hold over period by several hours, providing it is placed in the uppermost drawer, at the front, above the frozen food.

You can also use the cold accumulation block in a cool bag.

Control Panel

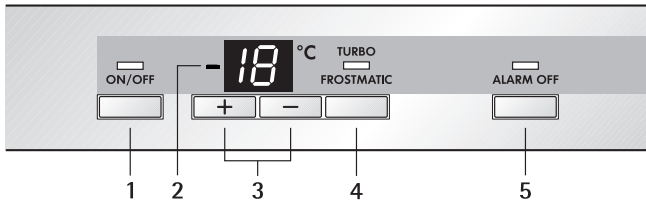

- 1 ON/OFF button and ON/OFF indicator light (green)
- 2 Temperature display
- 3 Temperature setting buttons
- 4 TURBO/FROSTMATIC button and TURBO/FROSTMATIC indicator light (yellow)
- 5 ALARM OFF button and warning indicator light (red)
(see section: "Control and Information Systems")

Temperature setting buttons



The temperature is adjusted using the „+“ (WARMER) and „-“ (COLDER) buttons.

These buttons are connected to the temperature display.

- The temperature display is switched over from the display of the ACTUAL temperature (Temperature display is illuminated) to the display of the DESIRED temperature (Temperature display flashes) by pressing one of the two buttons, „+“ (WARMER) or „-“ (COLDER).
- Each time one of the two buttons is pressed again the DESIRED temperature is adjusted by 1 °C.
- If neither button is pressed, the temperature display automatically switches back after a short period (approx. 5 sec.) to the display of the ACTUAL temperature. The ACTUAL temperature in the appliance is now adjusted to match the preset DESIRED temperature.

DESIRED temperature means:

The temperature that is required in the appliance, this can be adjusted to the temperatures shown in the display. The DESIRED temperature is indicated by flashing numbers.

ACTUAL temperature means:

The temperature display indicates the temperature that is currently present in the appliance. The ACTUAL temperature is indicated with illuminated numbers.



Once the TURBO/FROSTMATIC function has been switched on the DESIRED temperature that was set originally cannot be changed.

Temperature display



The temperature display shows several types of information.

- In normal operation the current freezer compartment temperature is displayed (ACTUAL temperature).
- During temperature adjustment, a blinking display of the temperature selected at the moment occurs (DESIRED temperature).
- In the TURBO/FROSTMATIC function of the cooling mode "IC" for intensive cooling appears in the display .
The current freezer temperature appears in the display while TURBO/FROSTMATIC is functioning during freezing mode. If one of the temperature setting buttons is pressed, "SF" (Super Frost) will appear in the display for 5 seconds. The display will then revert to showing the current freezer temperature.
- In the event that frozen food has been partially or totally defrosted, perhaps as the result of a lengthy power failure and if the ALARM OFF button is activated the temperature display will show the warmest temperature the frozen food has reached on restoration of the power supply.
- If there is a fault in the appliance a square or a letter will appear in the temperature display.

TURBO/FROSTMATIC-button



The TURBO/FROSTMATIC function in the freezing mode provides for quick freezing of fresh food products, and at the same time protects previously stored goods against undesired warming in the freezer compartment.

In the cooling mode the TURBO/FROSTMATIC function is suitable for fast cooling larger quantities of foodstuff, e.g. drinks or salads during a party. Thereby a DESIRED temperature of +2 °C is automatically preset.

-  1. The TURBO/FROSTMATIC function is switched on by pressing the TURBO/FROSTMATIC button. The yellow light illuminates. The display shows „SF“ in the freezing mode. After 5 seconds the display changes to show the actual temperature again. In the cooling mode the display shows „IC“. The compressor runs continuously.
2. The TURBO/FROSTMATIC function can be ended manually at any time by pressing the TURBO/FROSTMATIC button again. The yellow light goes out. If the TURBO/FROSTMATIC function is not ended manually, the appliance electronics switch off the TURBO/FROSTMATIC function of the freezing mode after approx. 50 hours, and the TURBO/FROSTMATIC function of the cooling mode after 6 hours. The yellow light goes out.
Important! Once the TURBO/FROSTMATIC function has been switched on the DESIRED temperature that was set originally cannot be changed.

ALARM OFF button



With the ALARM OFF button, the acoustic warning signal can be switched off, e.g. the "Open Door" warning when sorting in or out, the food to be frozen.



When there is a temperature warning, if the ALARM OFF button is activated, following a power cut, the temperature display will show the warmest temperature the frozen food has reached on restoration of the power supply.

Prior to Initial Start-Up

 Before connecting the appliance to the mains and putting it into operation for the first time, leave the appliance to stand for 30 minutes if was transported upright. After transport on its side, the appliance must be left to stand for 2 hours before putting it into operation. This is necessary to allow the refrigerant to flow back into the compressor. Otherwise the compressor may be damaged.

-  1. Please clean the appliance interior and all accessories prior to initial start-up (see section: "Maintenance and Cleaning").
2. The appliance must be correctly installed in accordance with the chapter "Installation" before it is put into operation for the first time. Care should be especially taken that the mains voltage and frequency available correspond with the appliance's rating plate.
 3. Remove the cold accumulation block from the appliance.
 4. Only put the cold accumulation block to freeze in the top compartment after the optimal storage temperature of $-18\text{ }^{\circ}\text{C}$ has been reached.
 5. After 24 hours place the cold accumulation block in the uppermost compartment, at the front, above the frozen food.
 6. Re-freeze the thawed cold accumulation block in the same way, e. g. after cleaning the appliance.

Initial use

-  1. Insert plug into mains socket.
2. Press ON/OFF button. The green pilot light illuminates.
A warning tone sounds and the red warning light flashes indicating that the required storage temperature has not yet been reached.
 3. Press the ALARM OFF button to switch off the warning tone.
 4. Set temperature to $-18\text{ }^{\circ}\text{C}$ or colder (see section: "Temperature Adjustment").
Important! Wait until the freezer compartment has reached a temperature of $-18\text{ }^{\circ}\text{C}$, or the red warning light has gone out, before storing frozen food.
-  In the delivery state, your appliance is present in the operation mode "Freezing".
If the appliance was once in operation, it restarts in the operation mode, which was set prior to switching off.

Select "Freezing" or "Cooling"

If necessary, switch over the appliance with the following steps between the operating modes "Freezing" and "Cooling":

1. Hold down the ALARM OFF button and the „-“ (COLDER) button simultaneously for 5 seconds.
 - When the setting is switched from "Freezing" to "Cooling" "FC" (Freezing -> Cooling) appears in the temperature display, an acoustic signal confirms the change and the temperature display changes to flashing figures (DESIRED temperature cooling mode +5 °C). Using the temperature setting buttons, the required temperature for the cooling mode can now be entered.
 - When the setting is switched from "Cooling" to "Freezing" "CF" (Cooling -> Freezing) appears in the temperature display, an acoustic signal confirms the change and the temperature display changes to flashing figures (DESIRED temperature freezing mode -18 °C). Using the temperature setting buttons, the required temperature for the freezing mode can now be entered.

 The operation mode, in which your appliance is at the moment, is identifiable if the temperatures can be set above or below 0 °C.

2. Set the temperature depending upon the selected operation mode (see the chapter "Temperature Adjustment").

Attention! If you are using the appliance as a freezing unit: Please wait prior to putting the foodstuff to be frozen, until the freezer interior temperature has attained -18 °C, or until the red warning display goes off.

Attention! If you are using this appliance as a cooling unit, after it has been used as a freezing unit: Please wait until the temperature has reached 0 °C before putting the foodstuff to be cooled in the appliance.

Temperature Adjustment

1. Press either the „+“ (WARMER) or „-“ (COLDER) button.

The temperature display switches over and the DESIRED temperature currently set flashes on the temperature display.
2. To adjust to a warmer temperature, press the „+“ (WARMER) button. To adjust to a colder temperature, press the „-“ (COLDER) button. The changed setting is immediately displayed on the temperature display.

Each time one of the two buttons is pressed again the DESIRED temperature is adjusted by 1 °C.

The following DESIRED temperature settings are possible:

- Operating mode "Freezing": from -15 °C up to -24 °C in 1 °C steps;
- Operation mode "Cooling": from 0 °C up to 16 °C in 1 °C steps;

Note: From a food safety point of view, -18 °C for the freezer compartment should be considered cold enough as a storage temperature.

i If the buttons are not pressed again for approx. 5 seconds the temperature display will change from the DESIRED temperature to the ACTUAL temperature. The display changes from flashing to illuminated numbers.

Important! Please check red warning display and temperature display regularly to ensure maintenance of the storage temperature.

Switching the Appliance Off

In order to protect frozen goods, the appliance is guarded against accidental switching off (child-proof).

👉 1. To switch off press and hold the ON/OFF button for approx. 1 second. A so-called "count down" is started in the temperature display, which counts backwards from "3" to "1". After "1" is reached the appliance switches off. Illumination at the temperature display goes off.

i The appliance is only completely disconnected from the electricity supply when the power plug has been removed from the power outlet.

Note:

The appliance cannot be switched on or off if unplugged, or if there is no power being supplied to it.

Following connection to the mains power supply, the appliance returns to the same operating state as before the interruption of main power.

If the appliance is not going to be used for an extended period:

- 👉** 1. Switch appliance off by pressing and holding the ON/OFF button for approximately 1 second (see above).
2. Unplug or switch off at the mains supply.
 3. Clean thoroughly (see section: "Maintenance and Cleaning").
 4. Leave door open to avoid accumulation of odours.

i When put into operation again, the appliance starts in the operation mode, in which it was set prior to switching off.

Control and Information Systems

The control and information systems consist of the temperature display, an optical warning display and an acoustic warning.

The system warns:

- when first switching on the appliance (when the storage temperature has not yet been attained);
- if the appliance door remains open for longer than 80 seconds (operation mode "Freezing") or for longer than 5 minutes (operation mode "Cooling");
- of excessive temperature in the freezer compartment (only in the operation mode "Freezing");
- if there are functional errors with the appliance.

"Open Door" Warning

If the door remains open longer than approx. 80 seconds (operation mode "Freezing") or longer than 5 minutes (operation mode "Cooling"), the red warning indicator flashes and a warning tone sounds. If you need more time for sorting or rearranging frozen or cooled foodstuff, you can switch off warning tone for 80 seconds (operation mode "Freezing") or for 5 minutes (operation mode "Cooling") by pressing the ALARM OFF button.

The red warning indicator will go out when the door is closed.

Temperature Warning

(only in the operating mode "Freezing")

The red warning display and the temperature display flashes and an audible warning sounds, as soon as the temperature in the freezer compartment is warmer than $-11\text{ }^{\circ}\text{C}$.

A rise in temperature may be caused by:

- frequent door opening for long periods of time;
- loading with large quantities of warm foods;
- high ambient temperature;
- an error with the appliance.

 1. You can cancel the warning tone with the ALARM OFF button.

The temperature display for the freezer indicates the warmest temperature the freezer has reached during the temperature alarm period. After approx. 5 seconds the temperature display reverts to the current freezer temperature. The red warning indicator will switch off as soon as the temperature has dropped to under $-11\text{ }^{\circ}\text{C}$.

Temperature memory

i While the current freezer temperature is above $-11\text{ }^{\circ}\text{C}$, the warmest temperature the freezer has reached during the alarm period is stored and can be called up as often as wished by pressing the ALARM OFF button.

If the temperature in the freezer compartment drops to under $-11\text{ }^{\circ}\text{C}$ and the ALARM OFF button has not been pressed prior, the warning tone will switch off automatically. The red warning indicator and the temperature display will continue to flash.

If the ALARM OFF button is pressed now, the red warning indicator switches off. In addition, the temperature display will show for five seconds the highest temperature the frozen food has warmed to. Then the display will change to the current freezer temperature. The stored highest temperature is now erased.

Attention! If suspicion of partial or complete thawing exists, please check the quality of the foods to determine if they can be used.

Function Errors

If the appliance electronics detects a technical fault that needs to be rectified by customer service, the temperature display shows a square in the lower part of the temperature display or a letter. The red warning indicator flashes. The appliance will continue to operate in emergency mode.

Opening the door



If the door is closed when the appliance is in operation, it cannot be immediately opened again, because a vacuum occurs which holds the door closed until pressure has been equalised. The door can be opened again after several minutes.

Freezing

(only in the operating mode "Freezing")

Except for the bottom drawer, which serves for storage purposes, all compartments and drawers are suited for freezing small quantities of fresh food. The two upper compartments are suited for freezing of large quantities of food.

Important!

- The temperature in the freezer compartment must be $-18\text{ }^{\circ}\text{C}$ or colder before freezing food.
 - Please observe the freezing capacity given on the rating plate. The freezing capacity is the maximum quantity of fresh food that can be frozen within a period of 24 hours. If you wish to freeze food several days in a row, please observe a maximum capacity of only 2/3 to 3/4 of that on the rating plate.
 - Allow warm food to cool down before freezing. The warmth will cause increased ice formation and increase the power consumption.
 - When freezing large quantities of food, place the frozen cold accumulation block at the top of the cold food.
 - Thawed foods which have not been processed further (cooked into meals) may not under any circumstances be frozen a second time.
-  1. When freezing maximum capacity press the TURBO/FROSTMATIC button 24 hours prior to freezing, or 4 to 6 hours for smaller quantities. Yellow indicator light illuminates.
-  The TURBO/FROSTMATIC button need not be pressed for freezing of small quantities of up to 3 kg.
2. All foods must be packed air tight prior to freezing, so that they do not dry out or lose their flavour, and so that no flavour contamination of other frozen goods occurs.
- Caution!** Do not touch frozen food with wet hands. Your hands could freeze to the food.
3. Place the packed food in the drawers. Unfrozen food must not touch items already frozen, otherwise the frozen food could begin to defrost.
-  The appliance electronics automatically switch the TURBO/FROSTMATIC function off after a period of 50 hours. Yellow indicator light goes out. You can also stop the TURBO/FROSTMATIC function manually by pressing the TURBO/FROSTMATIC button again.

Tips:

- The following are suited for the packaging of frozen goods:
 - freezer bags and polyethylene wraps;
 - plastic containers for frozen goods;
 - extra-thick aluminium foil.
- The following are suitable for sealing bags and wrap:
plastic clips, rubber bands or tape.
- Smooth the air out of the bag before sealing; air makes it easier for the frozen food to dry out.
- Make flat packages, because these freeze more quickly.
- Do not fill plastic containers for frozen goods to the brim with liquid or paste-like goods, because liquids expand during freezing.

Frozen Storage

Important! Wait until the necessary storage temperature of $-18\text{ }^{\circ}\text{C}$ has been reached before storing food already frozen.

- Load the freezer only with packaged frozen goods, so that they do not dry out or lose their flavour, and so that no flavour contamination of other frozen goods can occur.
- Please observe maximum storage times and expiry dates of frozen goods.



Place frozen foods in the drawers sorted by type, as far as possible. This will give you a better overview of the contents, avoid extended door opening and therefore save electricity.



From a food safety point of view, $-18\text{ }^{\circ}\text{C}$ is deemed sufficient as cold storage temperature.

Preparation of Ice Cubes

1. Fill the ice cube tray $3/4$ full with cold water, place it in the freezer and leave to freeze.
2. To loosen the frozen cubes, either bend the ice cube tray or hold it under running water for a few seconds.

Important! Never try to free an ice tray that is frozen to the freezer compartment using pointed or sharp edged objects. Use a soft plastic scraper.

Storage Goods Symbols/Freezing Calendar

(not on all models)

- The symbols on the drawers show different types of frozen goods.



- The numbers indicate storage times in months for the appropriate types of frozen goods. Whether the upper or lower value of the indicated storage time is valid depends on the quality of the foods and pre-treating before freezing. The lower value applies to foods with high fat content.

Maximum Load

In order to load large quantities or bulky freezer items, you can remove the interior (except for the bottom drawer and the upper compartment lid, which serves for good ventilation) and place the freezer goods directly onto the storage grid.

However, when the drawers are removed, the stored items must not extend the load limit at the storage grid's front.

Cooling

The appliance is suitable, depending upon the preset temperature, for

- "Long Fresh" Cooling
- "Standard" Cooling
- Drinks cooling.

i The drawers of the appliance can be removed individually. The removal is then especially advantageous if due to its size the foodstuff you want to cool does not fit inside a drawer. You can in this case stack the drawer below correspondingly higher.

"Long Fresh" Cooling

By selecting the DESIRED temperature of 0 °C up to +2 °C this appliance can be used as a "Long Fresh" cooling unit.

The "Long Fresh" cooling process enables optimum storage conditions for fresh foodstuff. The foodstuff remains fresh up to three times longer in comparison to storage in normal refrigerators.

- Commodities suitable for "Long Fresh" cooling are:
 - meat and sausages
 - fresh poultry
 - fresh fish
 - milk, butter, curd cheese
 - berries, fruits and vegetables
 - salads, mushrooms.
- Foodstuff unsuitable for "long fresh" cooling are:
 - coldness-sensitive fruits, e.g. bananas, papayas, passion fruits, avocados and citrus fruits;
 - coldness-sensitive vegetables, e.g. paprika, cucumber, zucchini, egg-plants, potatoes and tomatoes;
 - Fruits and vegetables, which should still ripen, e.g. pears.
- Pack all foodstuffs prior to "long fresh" cooling. Thus, the aroma, the moisture and the colour is retained longer.
- The following are suited for packaging:
 - Airtight bags and foils made of polyethylene
 - Closable plastic containers
 - aluminium foil.

"Standard" Cooling

By selecting the DESIRED temperature in the range of +5 °C, this appliance can be used as a normal refrigerator.

- Foodstuff should always be covered or packed in the cool room, in order to prevent drying out and odour or taste transmission to other cooled foodstuffs.
- The following are suited for packaging:
 - Airtight bags and foils made of polyethylene
 - Plastic container with cover
 - Special hoods made of plastic with rubber band
 - aluminium foil.

Cooling drinks

By selecting the DESIRED-Temperature up to +16 °C, the appliance can perfectly be used as a cooling unit for drinks.

Hints and Tips

Normal Operating Sounds

- You may hear faint gurgling or bubbling sounds when the refrigerant is pumped through the coils or tubing at the rear, to the cooling plate/evaporator.
- When the compressor is on, the refrigerant is being pumped round and you will hear a whirring sound or pulsating noise from the compressor.
- A thermostat controls the compressor and you will hear a faint click when the thermostat cuts in and out.
- The ventilator generates air flow whereby noise can be emitted.

Food Storage

To obtain the best performance from your freezer:

- Do not store warm food or evaporating liquids.
- Do not store food uncovered.
- Keep the time between buying chilled food and placing it in your freezer as short as possible.
- Do not push food together too much, try to allow air to circulate around each item.



Energy Saving Advice

- Do not install the appliance close to sources of heat, such as a cooker, dishwasher or radiator.
- Locate the appliance in a cool well ventilated room and make sure that the air openings of the appliance are not obstructed.
- Always leave warm food to cool down to room temperature before placing in the freezer.
- Try to avoid keeping the door open for long periods or opening the door too frequently as warm air will enter the cabinet and cause the compressor to switch on unnecessarily often.
- Ensure there are no obstructions preventing the door from closing properly.

Maintenance and Cleaning

Before any maintenance or cleaning work is carried out **DISCONNECT** the appliance from the **ELECTRICITY** supply.

Internal Cleaning

-  1. Clean the inside and accessories with warm water and bicarbonate of soda (5 ml to 0.5 litre of water). Rinse and dry thoroughly.



Warning!

- Do not use detergents, abrasive powders, highly perfumed cleaning products, wax polishes or cleaning products containing bleach or alcohol.
2. Regularly check the door seals and wipe clean to ensure they are clean and free from debris.

External Cleaning



Warning!

- Do not use abrasive products
- There are sharp edges on the underside of the product so care should be taken when cleaning.



Important: Do not use cleaning agents for stainless steel or other aggressive or abrasive cleaning agents. The protective coat of lacquer on the stainless steel surface can be damaged by these.

The coat of lacquer protects against finger prints and therefore additional cleaning agents and maintenance products are no longer required.

-  1. Wash the outer cabinet with warm soapy water.
2. After cleaning wipe with fresh water and rub dry.



Accumulation of dust at the condenser increases energy consumption. For this reason carefully clean the condenser at the back of the appliance once a year with a soft brush or a vacuum cleaner.

What to do if ...

Correcting Malfunctions

Perhaps a malfunction has been caused by a minor error, which you can correct yourself with the help of the following instructions. Do not attempt any further repairs if the following instructions do not help in each specific case.



Warning! Freezers must only be repaired by trained personnel. Repairs carried out by untrained personnel can lead to substantial danger for the user. Please contact your local Service Force Centre for repairs or service.

Malfunction	Possible cause	Remedy
Appliance does not function, temperature display is not lit.	Appliance is not switched on.	Switch appliance on.
	Mains plug is not inserted or is loose.	Insert mains plug.
	Fuse has blown or is defective.	Check fuse, replace if necessary.
	Mains socket is defective.	Mains malfunctions are to be corrected by an electrician.
Red warning display flashes, temperature display shows temperature below -11 °C, door is closed.	Temperature Warning. Frozen goods have been warmed to such an extent that they have been partially or completely thawed.	Please refer to the section "Control and Information Systems".
Red warning display flashes, warning tone sounds, temperature display shows temperature above -11 °C, door is closed.	Temperature Warning. Frozen goods have been warmed to such an extent that they have been partially or completely thawed.	Please refer to the section "Control and Information Systems".
Red warning indicator is flashing, temperature display shows a square or a letter.	A functions error has occurred.	Please make a note of the indicated error and inform your local Service Force Centre. Do not open the appliance door again.

Malfunction	Possible cause	Remedy
The appliance is over-cooling.	The temperature has been set too low.	Temporarily select a higher temperature setting.
The freezer compartment temperature is insufficient.	Temperature is not properly adjusted.	Please refer to the section "Temperature Adjustment".
	Door was open for a long time.	Only leave the door open as long as necessary.
	Within the last 24 hours a large quantity of warm foods were loaded.	Press TURBO/FROSTMATIC button.
	Appliance is next to a source of warmth.	Please refer to the section "Installation Location".
Interior illumination does not function.	Light bulb is defective.	Please refer in this chapter under "Replace light bulb" .
Accumulation of frost at the door seal.	Door is not properly sealed (perhaps after reversing the door).	Carefully warm the door seal with a hand-held hair dryer at those points which are not airtight (no warmer than approx. 50°C). At the same time, shape the warmed door seal by hand, so that it is again properly seated.
Unusual noises.	Appliance is not level.	Readjust the front levelling feet.
	Appliance is in contact with wall or other objects.	Push appliance away a short distance.
	A part at the back of the appliance, e.g. a tube, is in contact with another appliance part or the wall.	Bend this part away carefully if necessary.
The compressor does not start immediately after pressing the TURBO/FROSTMATIC button, or after changing the temperature setting.	This is normal, no error has occurred.	The compressor starts after a period of time.

Malfunction	Possible cause	Remedy
Only temperatures above 0 °C can be set, although the appliance should be used as a freezing unit.	The appliance is in the operation mode "Cooling".	Selecting the operation mode "Freezing". For that, please refer in the "Select Freezing or Cooling" chapter.
Only temperatures below 0 °C can be set, although the appliance should be used as a cooling unit.	The appliance is in the operation mode "Freezing".	Select the operation mode "Cooling". For that, please refer in the chapter "Select Freezing or Cooling".

Replacing the light bulb

 **Warning!** Danger of electrical shock! Before replacing the light bulb switch appliance off and remove the mains plug, or switch off or disconnect from the electricity supply.

Light bulb specifications: 220–240 V, max. 25 W, socket: E 14

-  1. To switch the appliance off press and hold the ON/OFF button for approximately 1 second.
2. Remove mains plug.
3. For replacement of the light bulb press the cover and remove it like shown on the illustration.
4. Replace defective light bulb.
5. Place the cover again.

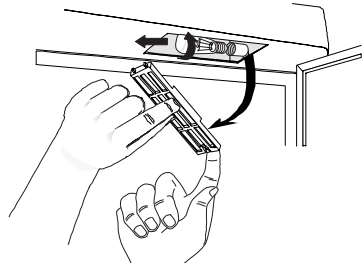

Regulations, Standards, Guidelines

This appliance was designed for household use and was manufactured in accordance with the appropriate standards. The necessary measures in accordance with appliance safety legislation regulations (GSG), accident prevention regulations for refrigeration appliances (VBG 20) and the regulations of the German Society of Electrical Engineers (VDE) were observed in the manufacture of this appliance.

The refrigerant circuit has been checked for leaks.

- CE** This appliance is in accordance with the following EU guidelines:
- 73/23/EEG dated 19 February 1973 - low voltage guidelines.
 - 89/336/EEG dated 3 May 1989
(including guideline change notice 92/31/EEG) - EMV guideline

Technical Terminology

- **Refrigerant**

Liquids that can be used to generate a cooling effect are known as refrigerants. They have a relatively low boiling-point, indeed so low, that the warmth from the food stored in the fridge or freezer can cause the refrigerant to boil and vaporise.

- **Refrigerant Circuit**

Closed circulation system that contains the refrigerant. The refrigerant circuit comprises primarily of an evaporator, a compressor, a condenser and pipe work.

- **Evaporator**

The refrigerant is evaporated in the evaporator. Similar to all other liquids, refrigerant requires heat to evaporate. This heat is removed from the interior of the appliance, as a result the interior is cooled. The evaporator is therefore located inside the appliance or placed in foam immediately behind the inner wall and thus not visible.

- **Compressor**

The compressor looks like a small drum. It is driven by a built-in electric motor and is mounted on the base of the appliance at the rear. The task of the compressor is to draw in vaporised refrigerant from the evaporator, to compress it, and to pass it on to the condenser.

- **Condenser**

The condenser normally has the form of a grid. The refrigerant compressed in the compressor is liquefied in the condenser. During this process, heat is released to the surrounding air at the surface of the condenser. The condenser is mounted on the base of the appliance.

Guarantee Conditions

Standard Guarantee Conditions

We, AEG, undertake that if within 12 months of the date of the purchase this AEG appliance or any part thereof is proved to be defective by reason only of faulty workmanship or materials, we will, at our discretion repair or replace the same FREE OF CHARGE for labour, materials or carriage on condition that:

- The appliance has been correctly installed and used only on the electricity or gas supply stated on the rating plate.
- The appliance has been used for normal domestic purposes only, and in accordance with the manufacturer's operating and maintenance instructions.
- The appliance has not been serviced, maintained, repaired, taken apart or tampered with by any person not authorised by us.
- All service work under this guarantee must be undertaken by a Service Force Centre. Any appliance or defective part replaced shall become the Company's property.
- This guarantee is in addition to your statutory and other legal rights.
- Home visits are made between 8.30am and 5.30pm Monday to Friday. Visits may be available outside these hours in which case a premium will be charged.

Exclusions

This guarantee does not cover:

- Damage or calls resulting from transportation, improper use or neglect, the replacement of any light bulbs or removable parts of glass or plastic.
- Costs incurred for calls to put right an appliance which is improperly installed or calls to appliances outside the United Kingdom.
- Appliances found to be in use within a commercial environment, plus those which are subject to rental agreements.
- Products of AEG manufacture which are not marketed by AEG.

European Guarantee

If you should move to another country within Europe then your guarantee moves with you to your new home subject to the following qualifications:

- The guarantee starts from the date you first purchased your product.
- The guarantee is for the same period and to the same extent for labour and parts as exists in the new country of use for this brand or range of products.
- This guarantee relates to you and cannot be transferred to another user.
- Your new home is within the European Community (EC) or European Free Trade Area.
- The product is installed and used in accordance with our instructions and is only used domestically, i.e. a normal household.
- The product is installed taking into account regulations in your new country.

Before you move please contact your nearest Customer Care centre, listed below, to give them details of your new home. They will then ensure that the local Service Organisation is aware of your move and able to look after you and your appliances..

France	Senlis	+33 (0) 3 44 62 29 29
Germany	Nürnberg	+49 (0) 800 234 7378
Italy	Pordenone	+39 (0) 800 117511
Sweden	Stockholm	+46 (0) 8 672 5360
UK	Luton	+44 (0) 8705 350 350

Service & Spare Parts

In the event of your appliance requiring service, or if you wish to purchase spare parts, please contact Service Force by telephoning:

08705 929 929

Your telephone call will be automatically routed to the Service Force Centre covering your post code area.

For the address of your local Service Force Centre and further information about Service Force, please visit the website at www.serviceforce.co.uk

Before calling out an engineer, please ensure you have read the details under the heading „What to do if....“

When you contact the Service Force Centre you will need to give the following details:

1. Your name, address and post code.
2. Your telephone number
3. Clear and concise details of the fault.
4. The model and serial number of the appliance (found on the rating plate).

• Model Name



• Model Number (PNC)



• Serial Number (S-No.)



5. The purchase date

Please note that a valid purchase receipt or guarantee documentation is required for in-guarantee service calls.

Customer Care

For general enquiries concerning your AEG-Electrolux appliance, or for further information on AEG-Electrolux products please contact our Customer Care Department by letter or telephone at the address below or visit our website at www.aeg.co.uk.

Customer Care Department
Major Appliances
AEG Domestic Appliances
Addington Way
Luton
Bedfordshire, LU4 9QQ
Tel: 08705 350350 (*)

For Customer Service in the Republic of Ireland please contact us at the address below:
AEG/ Electrolux Group (Ire) Ltd
Long Mile Road/ Dublin 12
Republic of Ireland
Tel: +353 (0) 1 4090754
Email: service.eid@electrolux.ie

(*) Calls may be recorded for training purposes

 **From the Electrolux Group. The world's No. 1 choice.**

The Electrolux Group is the world's largest producer of powered appliances for kitchen, cleaning and outdoor use. More than 55 million Electrolux Group products (such as refrigerators, cookers, washing machines, vacuum cleaners, chain saws and lawn mowers) are sold each year to a value of approx. USD 14 billion in more than 150 countries around the world.

AEG Hausgeräte GmbH
Postfach 1036
D-90327 Nürnberg

<http://www.aeg.hausgeraete.de>

© Copyright by AEG

818 35 94 – 01/2 – 0705

Subject to change without notice